



Features

- ◆ Sealed Construction, No Tape Seal Required
- ◆ Surface Mount, Thru-Hole and Right Angle 2.54 & 5.08mm
- ◆ Octal, Decimal and Hexadecimal Code in Real or Complement
- ◆ Gold-Plated Contacts
- ◆ Flush or Extended Rotors
- ◆ Knobs available
- ◆ Washable meet IP67

Specifications

- ◆ Contact Rating
 - Switching : 5VDC 20mA (Min. AC/DC 20mA 1µA)
 - Non Switching : Max. 50VDC 100mA
- ◆ Contact Resistance : 100mΩ Max
- ◆ Insulation Resistance : 1,000MΩ Min. at 100VDC
- ◆ Dielectric Strength : 250VAC for 1 minute
- ◆ Operating Force : 400gf/cm Max. (Standard)
: 200gf/cm Max. (N type)
- ◆ Life : 20,000 Steps
- ◆ Operating Temperature : -40°C ~+85°C
- ◆ Storage Temperature : -40°C ~+85°C
- ◆ Hand Soldering : 350°C 3 Sec. max
- ◆ Wave Soldering : 260±5°C for 10 sec. max.
- ◆ Reflow Soldering : Peak temp.: 245°C max. The time above 240 must be 30 sec. max.

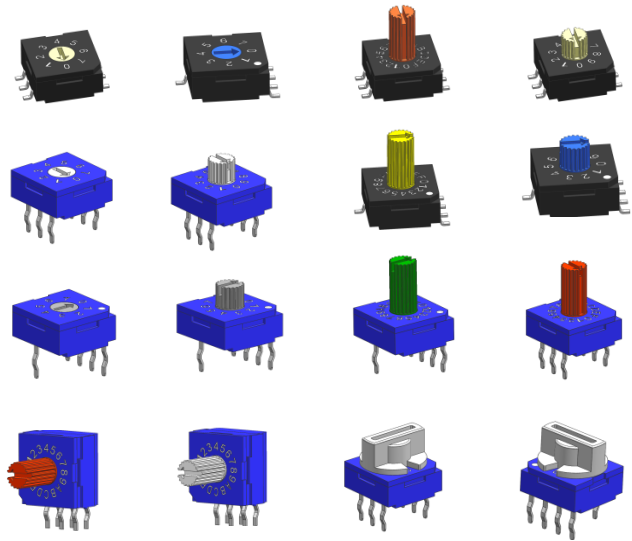

Code Format

No. of positions		(10 positions)										(16 positions)						
		(08 positions)																
		Position	0	1	2	3	4	5	6	7	8	9	A	B	C	D	E	F
Code	Real code	8																
		4																
		2																
	Complementary code	1																
		8																
		4																
		2																
		1																

Package

P/N	No. Of Pole	Quantity per Tube
R92_H/D/T/S	08 / 10 / 16	50
R92_V/Y	08 / 10 / 16	45
R93_H/D/T/S	08 / 10 / 16	50
R93_V/Y	08 / 10 / 16	45
R94_H/D/T/S	08 / 10 / 16	50
R94_V	08 / 10 / 16	45
P/N	No. Of Pole	Quantity per Reel
R9_0/1S-R	08 / 10 / 16	600
R9_2/3S-R	08 / 10 / 16	350
R9_7S-R	08 / 10 / 16	200
R9_7H/T-R	08 / 10 / 16	140

Position

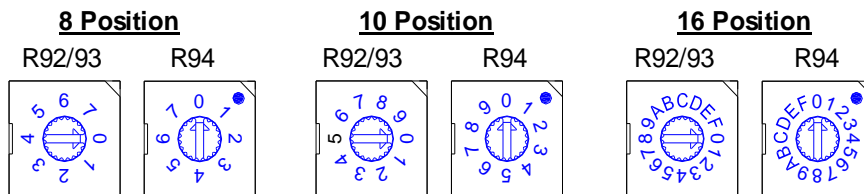

Order Information

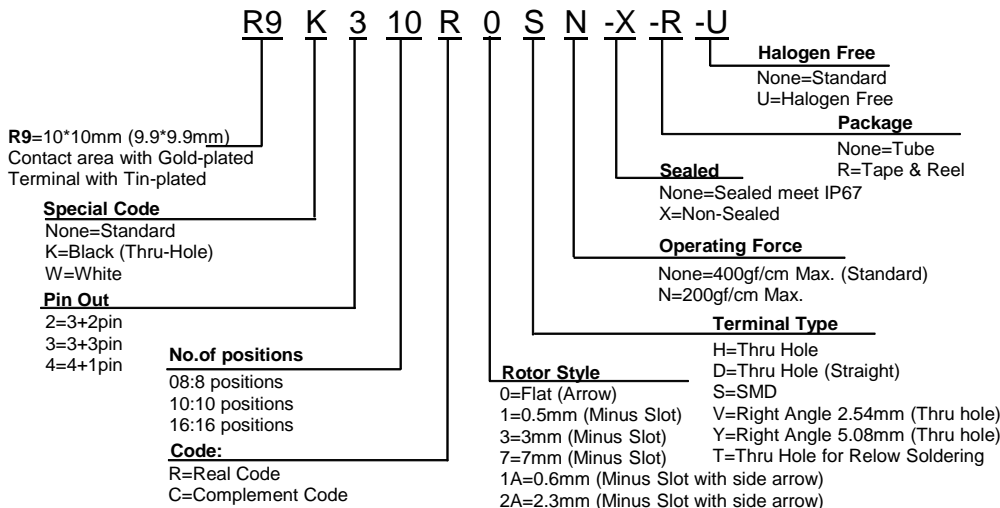

Knob Order Information

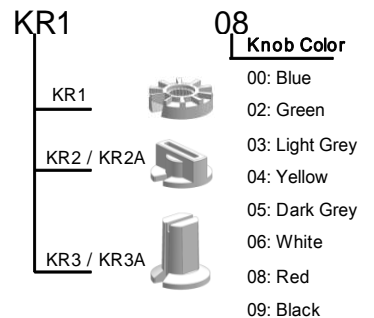



Rotor

Flat

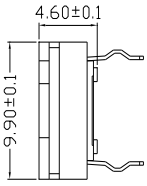

0.5mm

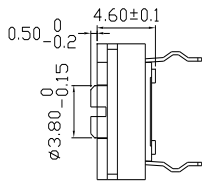

0.6mm

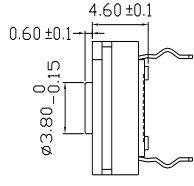

2.3mm

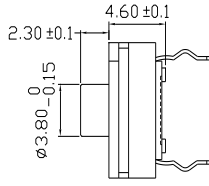

3mm

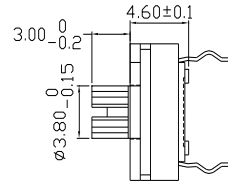

7mm

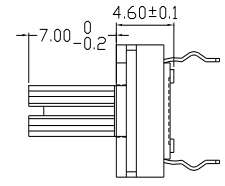

R9 - H/D (Thru-Hole)

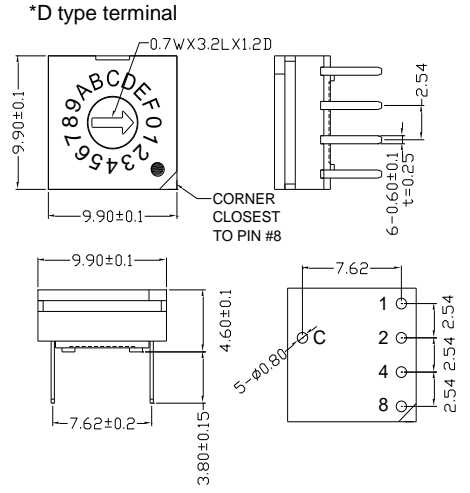
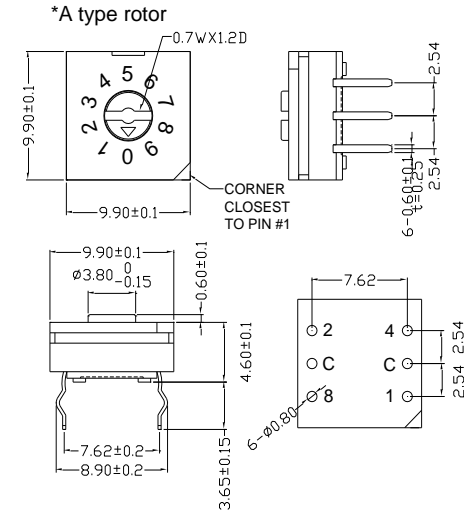
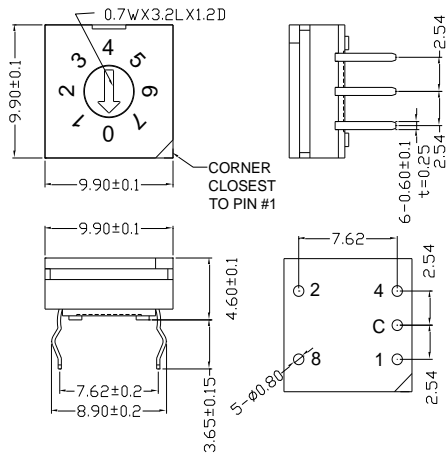

R9 - S (SMD)

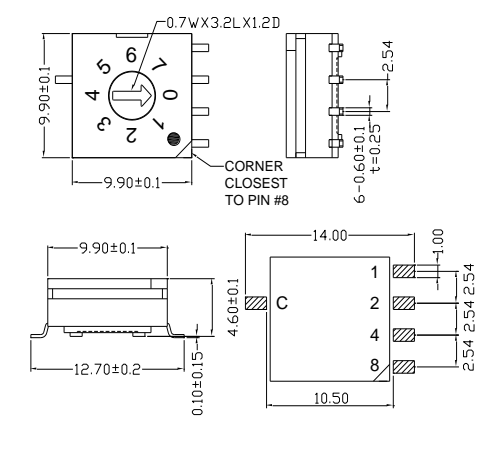
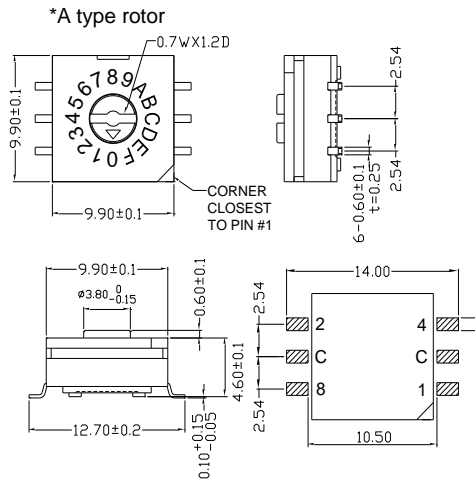
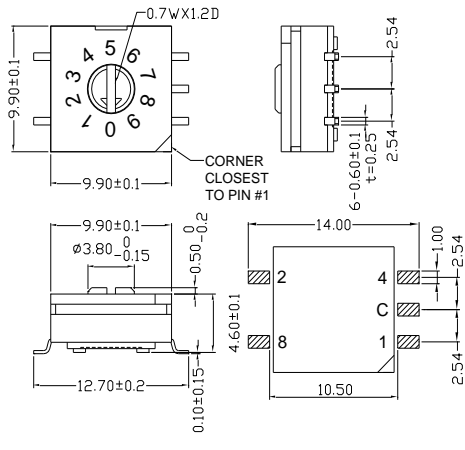

R9 - V (Right Angle 2.54mm)

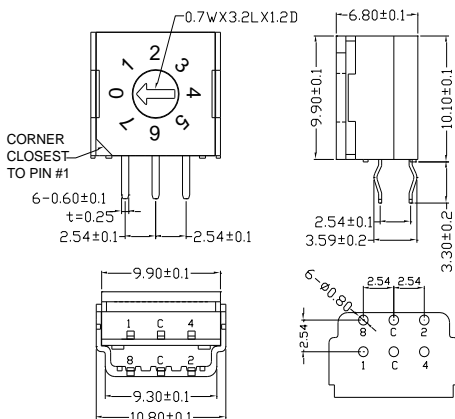

R9 - Y (Right Angle 5.08mm)

